

GE Healthcare

The GE Adventure Series™

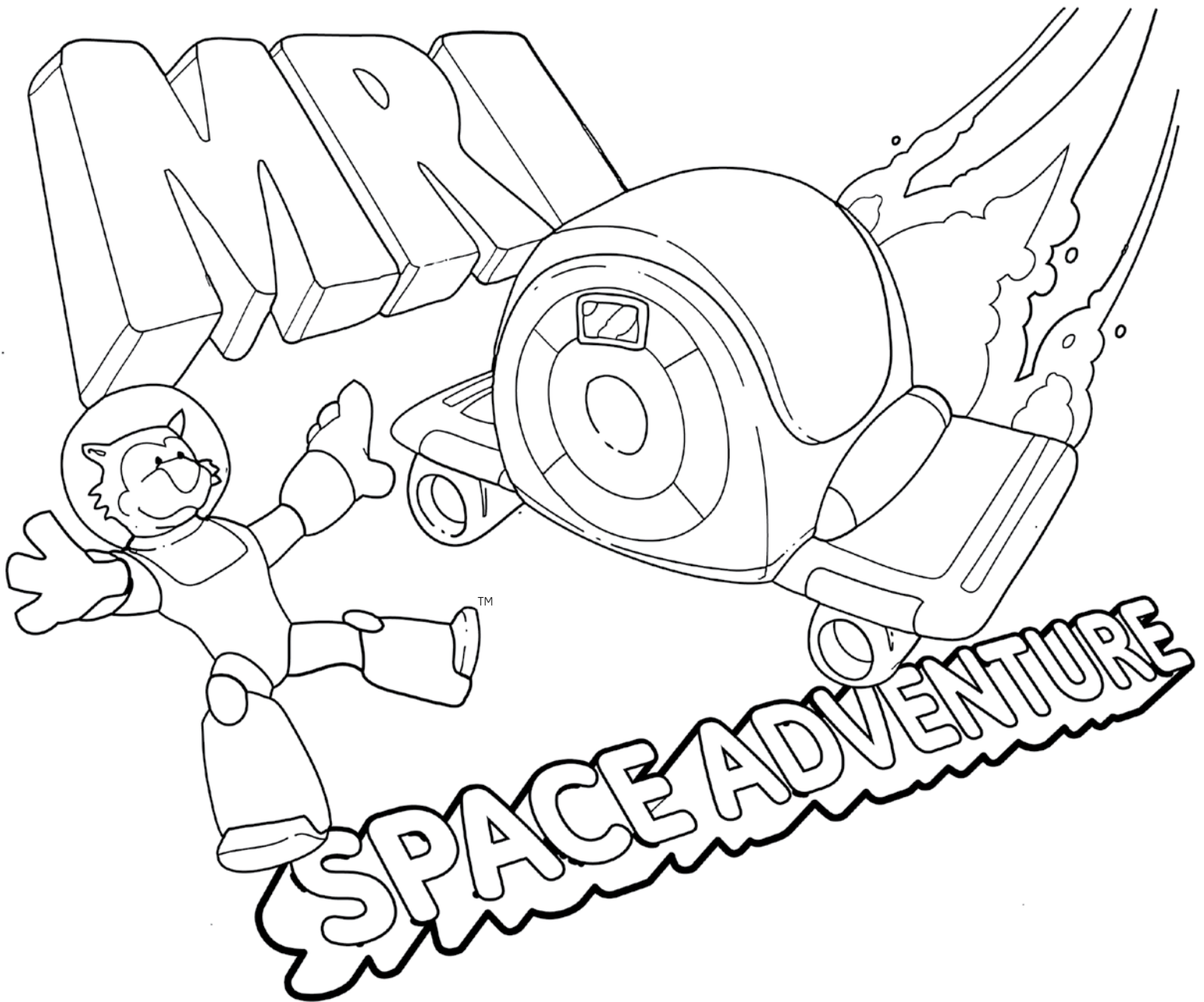

WELCOME!



Tips for the adult

In simple terms, tell the child why she is at the hospital. Use staff as a resource to help explain the process to the child.

**YOU WILL GET A SPECIAL BRACELET TO WEAR.
THIS WILL BE YOUR TICKET TO RIDE THE MRI SPACESHIP.**



Tips for the adult

The bracelet provides proper identification of the child and promotes safety.

WHAT IS AN MRI ANYWAY?



REGULAR PICTURE

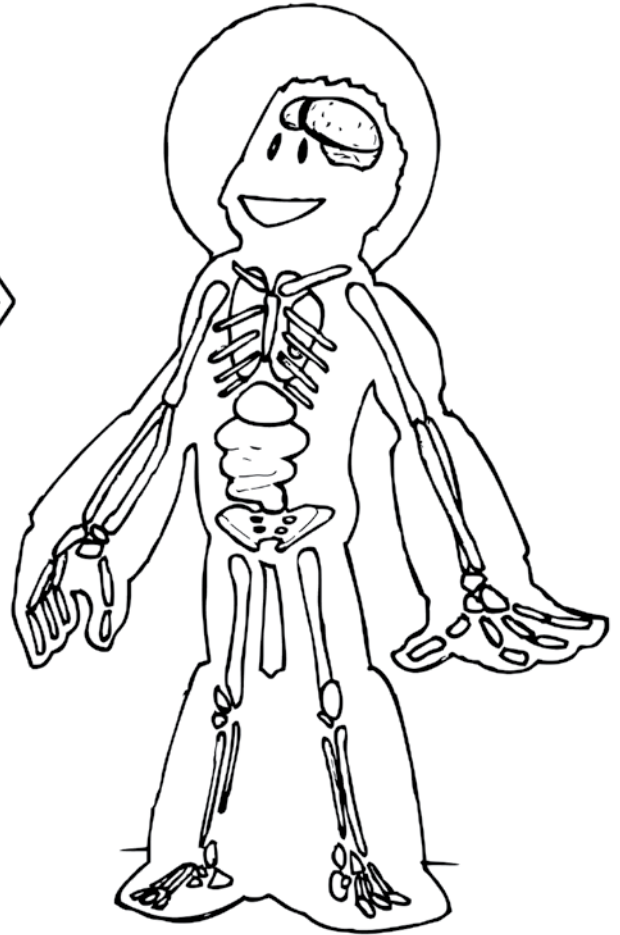
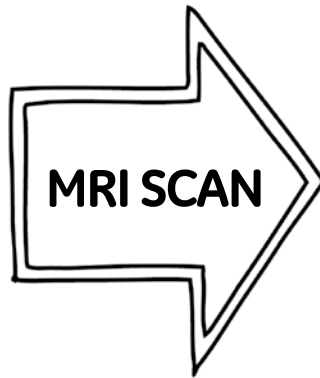

MRI PICTURE

**AN MRI IS A VERY SPECIAL PICTURE OF YOUR
MUSCLES & ORGANS INSIDE OF YOUR BODY.
DID YOU KNOW THAT AN MRI HELPS DOCTORS
SEE YOUR MUSCLES AND ORGANS?**

Tips for the adult

Talk about muscles and organs with the child.

**THE MRI MACHINE USES A REALLY STRONG
MAGNET TO TAKE YOUR PICTURES.**

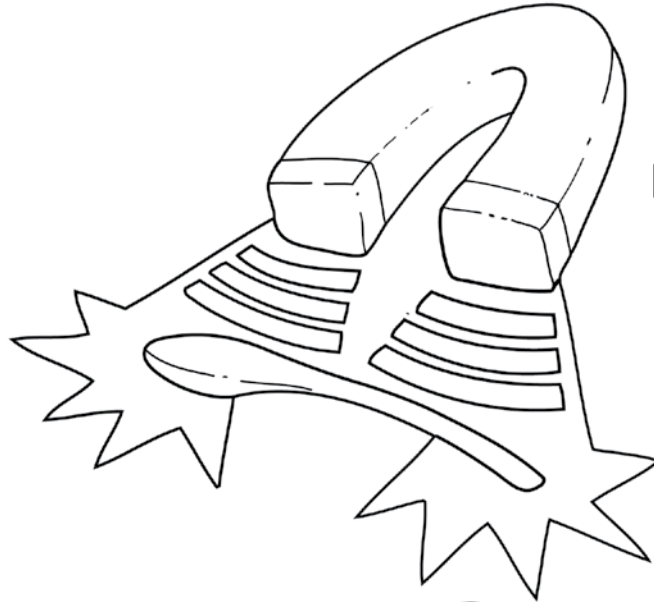

MAGNET

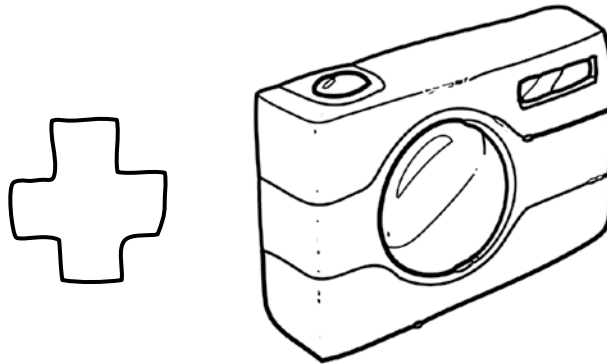

CAMERA

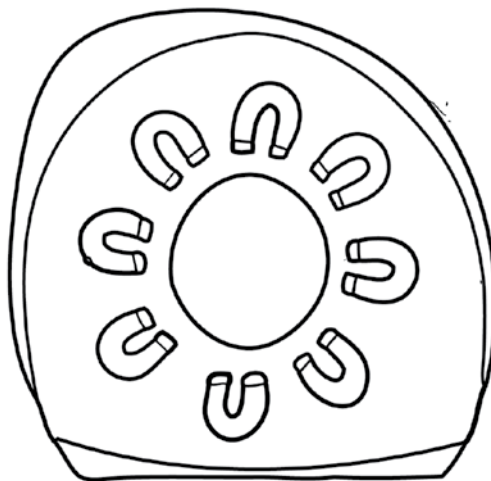
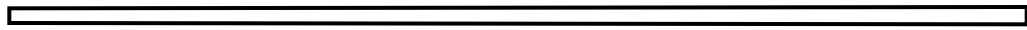

MRI

DO YOU KNOW WHAT A MAGNET IS?

Tips for the adult

Feel free to discuss magnets at this time. Patients or anyone present during the test will need to be screened for metal.

WHEN THE NURSE TAKES YOU TO THE NEXT ROOM, YOU CAN SIT ON THE BED, WATCH TV OR EXPLORE THE TREASURE CHEST.

THE ADULTS WILL TALK.

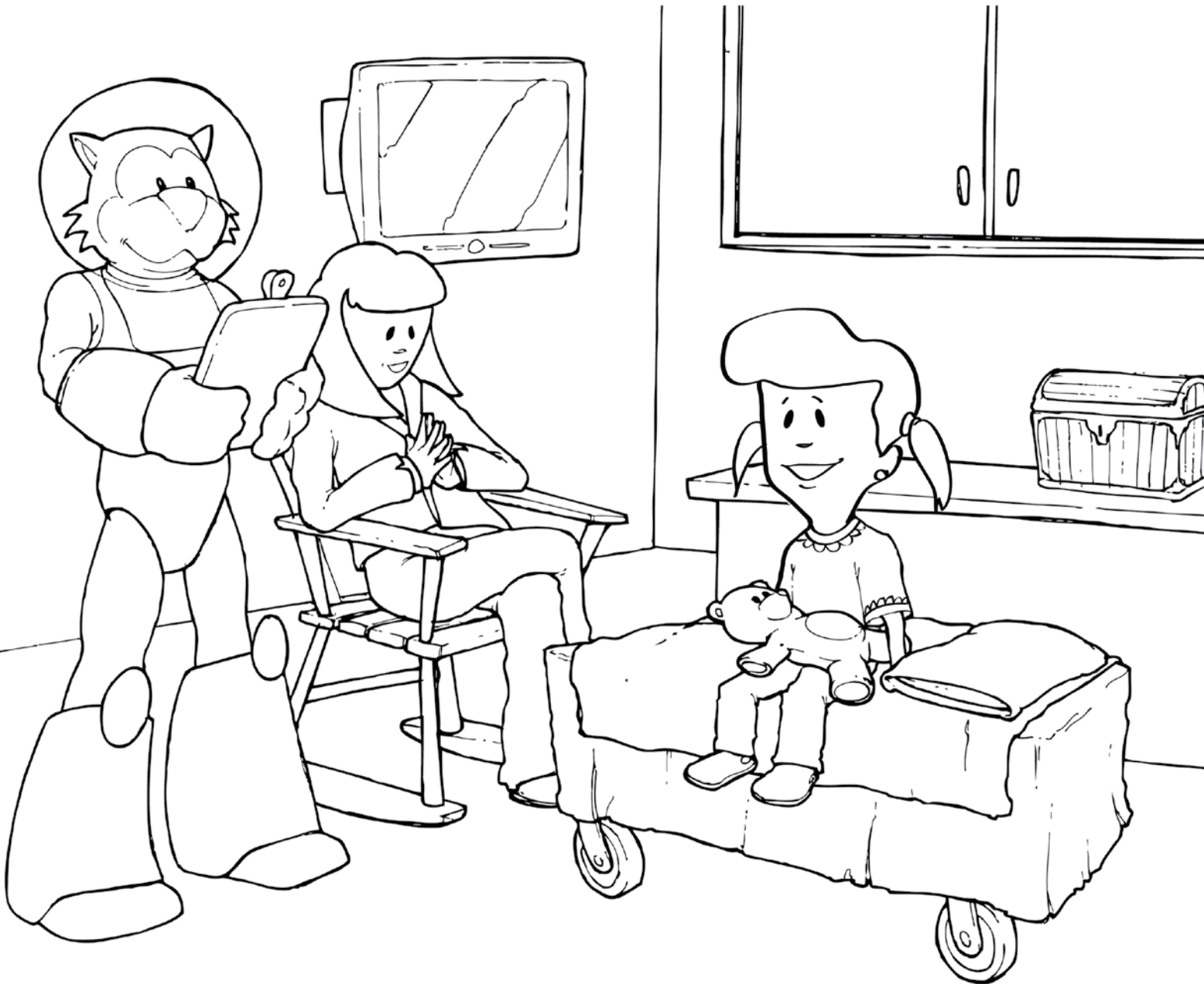

Tips for the adult

Comfort items that do not contain metal, such as blankets or stuffed animals may accompany the child during the test. Be sure to check items with the staff.

**THIS IS HOW YOU WILL LOOK WHEN
YOU LAY ON THE TABLE.**

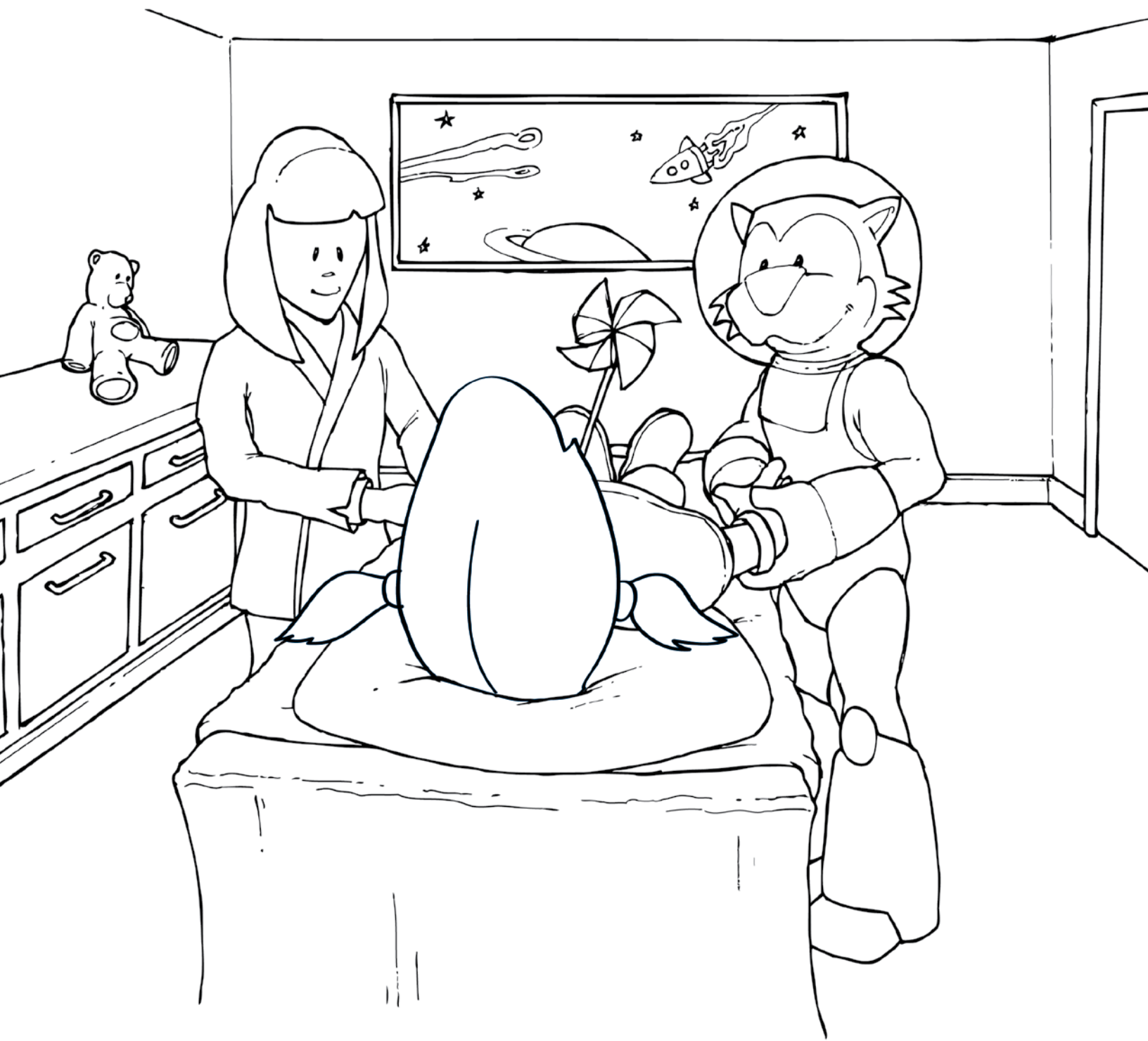

Tips for the adult

Assure the child that the staff is here to help.

BEFORE THE MRI MACHINE CAN TAKE YOUR PICTURE, YOU WILL HAVE TO PUT ON A SPECIAL SPACE SEAT BELT SO YOU ARE SAFE!

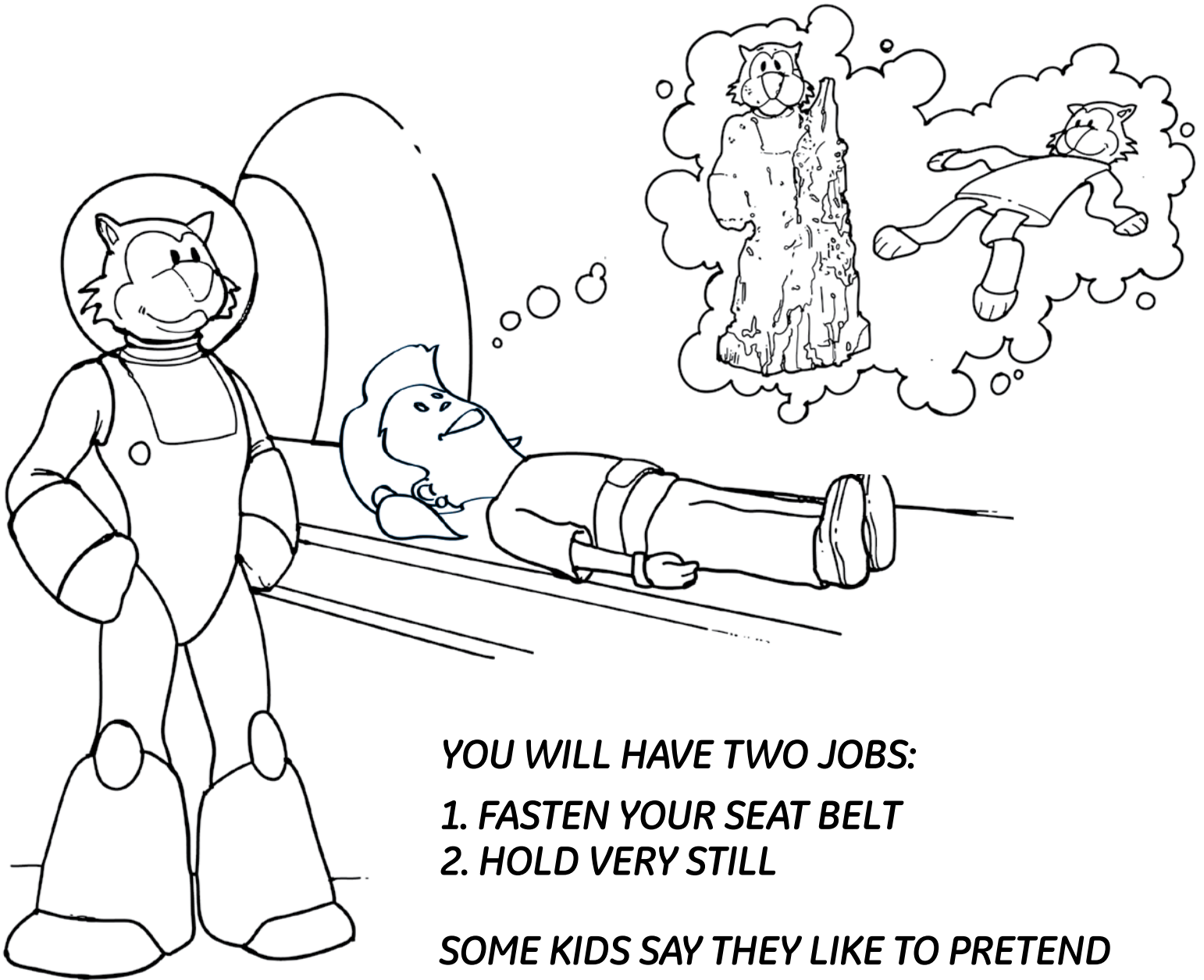

YOU WILL HAVE TWO JOBS:

- 1. FASTEN YOUR SEAT BELT**
- 2. HOLD VERY STILL**

SOME KIDS SAY THEY LIKE TO PRETEND THAT THEY ARE A STATUE OR A RAG DOLL. WHAT DO YOU WANT TO PRETEND TO BE?

Tips for the adult

*What helps your child relax?
Singing a favorite song? Taking slow, deep breaths?
Holding a stuffed animal?*



**WHILE THE CAMERA IS TAKING YOUR PICTURE, YOU CAN
WATCH A MOVIE WITH GOGGLES & HEADPHONES!
WE HAVE LOTS OF GREAT MOVIES TO CHOOSE FROM
TO WATCH DURING YOUR SPACE ADVENTURE!**

Tips for the adult

Staff have a pair of goggles and headphones for the child to try on.

If the patient is interested in the goggles, ask staff about availability

**REMEMBER YOUR JOB... TO LAY VERY STILL!
ONCE THE MRI CAMERA TAKES ALL OF YOUR
PICTURES, THE STAFF WILL LET YOU KNOW THAT
YOU ARE ALL DONE!**

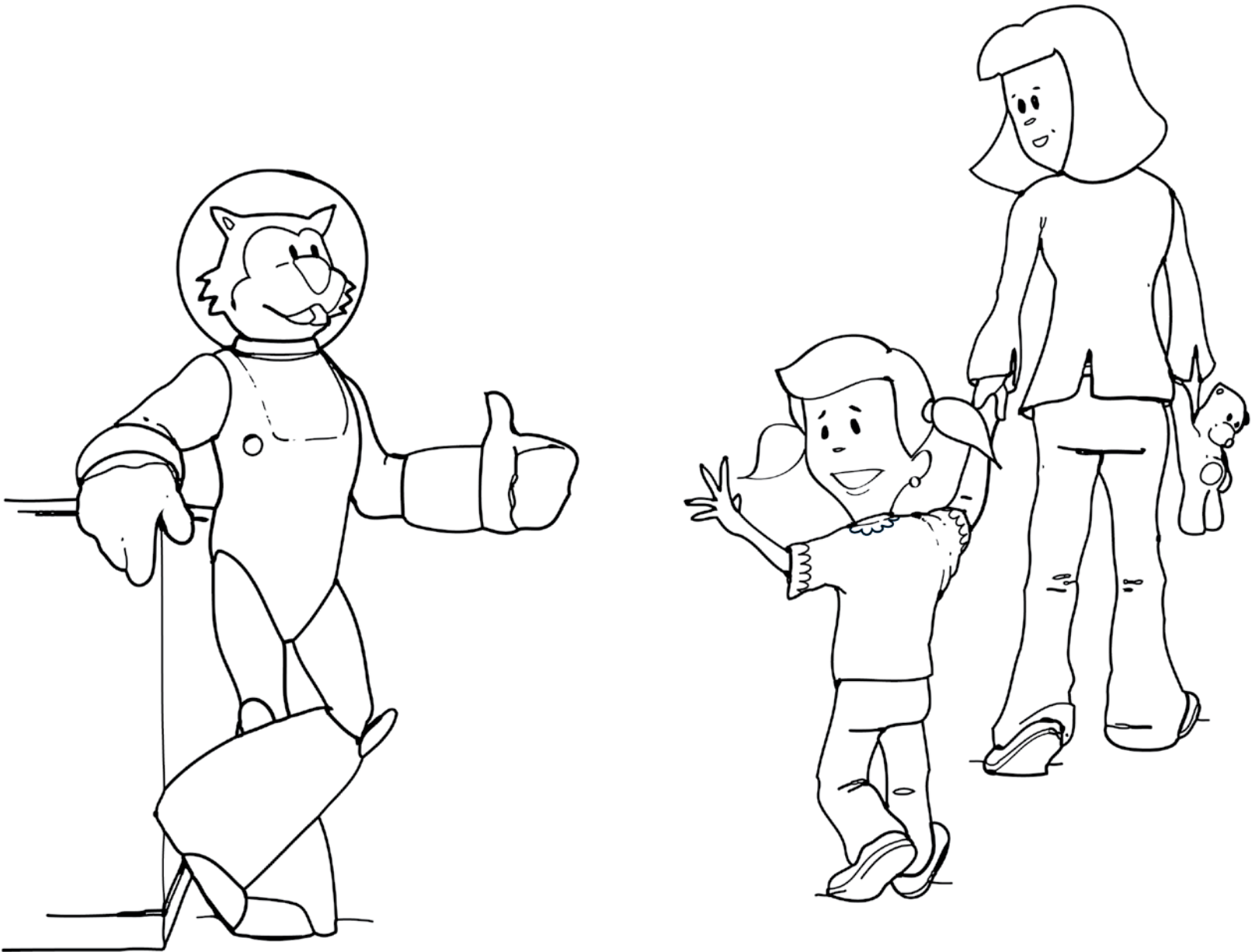

YOUR SPACE ADVENTURE IS OVER! YOU DID A GREAT JOB!

Tips for the adult

If you plan to stay in the room during the MRI, ask the child if it would be helpful to stay connected through touch.

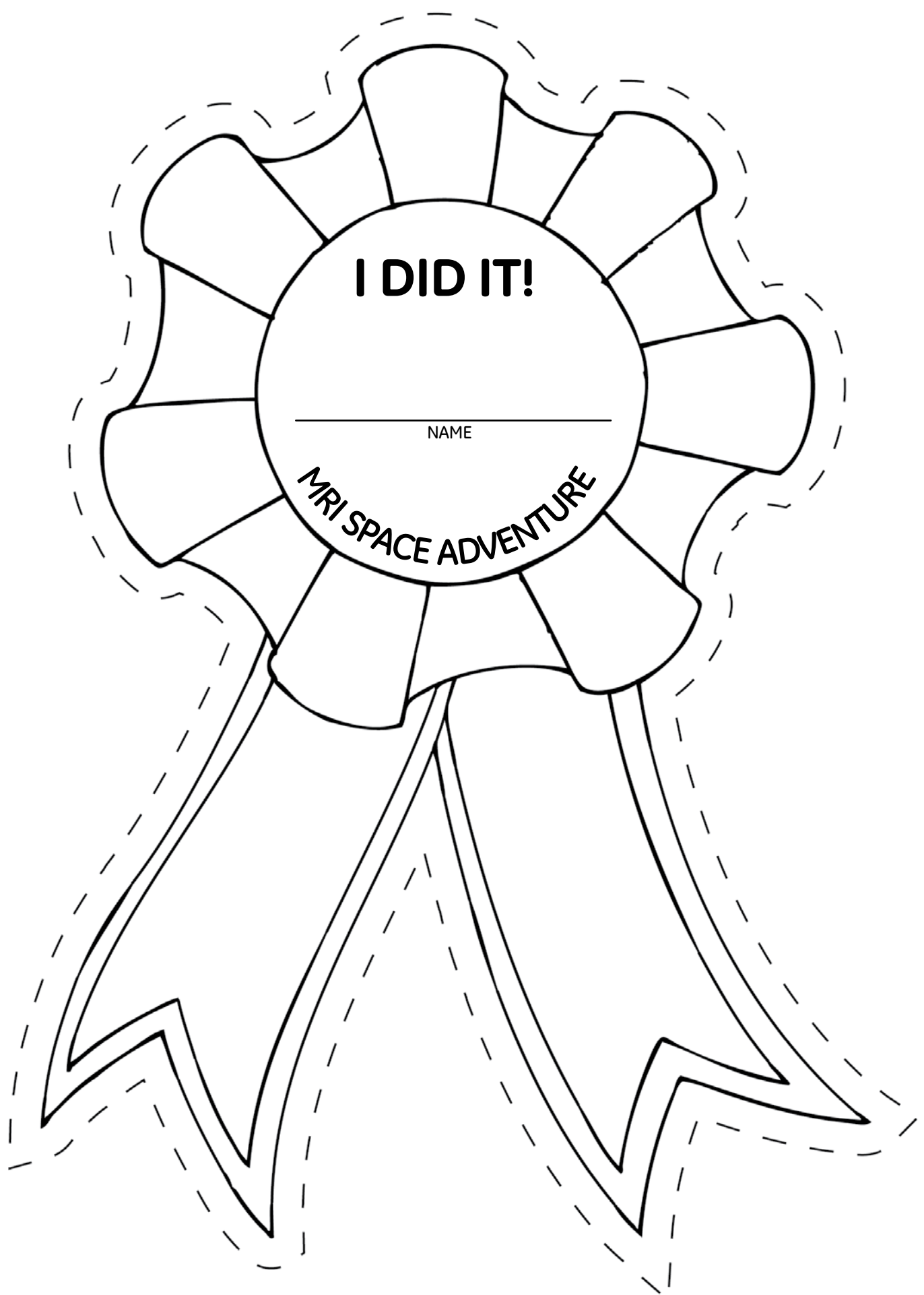

I DID IT!

NAME

MRI SPACE ADVENTURE

©2010 General Electric Company – All rights reserved.
GE and GE Monogram are trademarks of
General Electric Company. GE Healthcare,
a division of General Electric Company.

General Electric Company reserves the right to make
changes in specification and features shown herein, or
discontinue the product described at any time without
notice or obligation. Contact your GE representative for
the most current information.

GE Adventure Series and GE Adventure Series Characters
within this publication are trademarks of GE Healthcare.

About GE Healthcare:

GE Healthcare provides transformational medical technologies and services that are shaping a new age of patient care. Our broad expertise in medical imaging and information technologies, medical diagnostics, patient monitoring systems, drug discovery, biopharmaceutical manufacturing technologies, performance improvement and performance solutions services help our customers to deliver better care to more people around the world at a lower cost. In addition, we partner with healthcare leaders, striving to leverage the global policy change necessary to implement a successful shift to sustainable healthcare systems.

Our “healthymagination” vision for the future invites the world to join us on our journey as we continuously develop innovations focused on reducing costs, increasing access and improving quality around the world. Headquartered in the United Kingdom, GE Healthcare is a unit of General Electric Company (NYSE: GE). Worldwide, GE Healthcare employees are committed to serving healthcare professionals and their patients in more than 100 countries. For more information about GE Healthcare, visit our website at www.gehealthcare.com

GE Healthcare
3000 North Grandview Blvd
Waukesha, WI 53188
U.S.A.
www.gehealthcare.com



imagination at work